

CLS : CLOSE LIMIT SWITCH (250VAC 10A)
 OLS : OPEN LIMIT SWITCH (250VAC 10A)
 CTS : CLOSE TORQUE SWITCH (250VAC 10A)
 OTS : OPEN TORQUE SWITCH (250VAC 10A)
 ACLS : AUX. CLOSE LIMIT SWITCH (250VAC 10A)
 AOLS : AUX. OPEN LIMIT SWITCH (250VAC 10A)
 TP : THERMAL PROTECTOR (250VAC 15A OPTION)
 *EACH ACTUATOR SHOULD BE POWERED THROUGH ITS OWN INDIVIDUAL SWITCH OR RELAY CONTACTS TO PREVENT CROSS FEED BETWEEN TWO OR MORE ACTUATORS.

TORQUE AND LIMIT SWITCHES OPERATION

SWITCH	CLOSE ←	INTERMEDIATE	→ OPEN
CLS 1-2			
CLS 1-3			
OLS 1-2			
OLS 1-3			
ACLS1-2			
ACLS1-3			
AOLS1-2			
AOLS1-3			
CTS 1-3	* CLOSING TORQUE SWITCH INTERRUPTS CONTROL IF MECHANICAL OVERLOAD OCCURS DURING CLOSING CYCLE		
OTS 1-3	* OPENING TORQUE SWITCH INTERRUPTS CONTROL IF MECHANICAL OVERLOAD OCCURS DURING OPENING CYCLE		

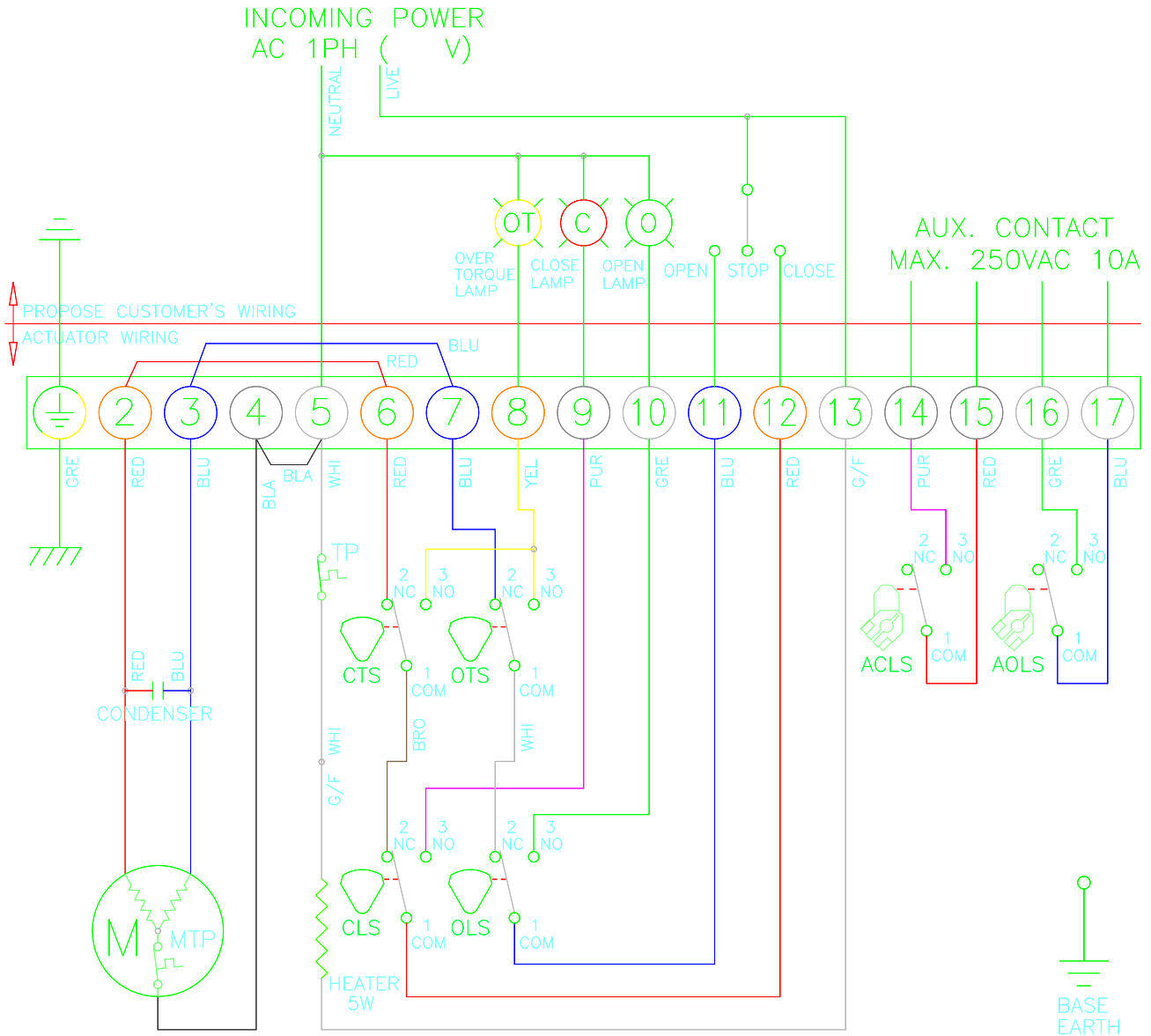

PE-1100		 www.pikevalves.com	DRAWN	DESIGN	CHECKED	APPROVER
PE-0810			C.J.	C.J.		
PE-0590						
PE-0370		PART NAME	ISSU. DEPT.	DATE	SIZE	PROGRAM
PE-0250		1PH WIRING DIAGRAM	ITCDR	2003.10.15	A4	AUTO CAD
PE-0175		OPTION NAME	DWG NO			
PE-0120	PE-2210	ALS	PE-W-OC-1-LS_0250-0370			
APP'L,FILE	PE-1475					